

Sink Quadra R12

Kitchen Sinks

Code: 1717 050



DETAILS

Material AISI 304 stainless steel

Texture Brushed in line

Finish Foster brushed

Edge/Installation Type Flush-mount | Top-mount

Base 80 cm

Dimensions 750 x 440 mm

Bowl dimension 710 x 400 mm

Width 75 cm

Built-in hole [View technical data sheet](#)

Number of bowls	1 bowl
Standard fittings	Fixing hooks, gasket, drain, overflow and siphon, boxed packing
Drainer	No
Mixer holes	No standard holes
Waste fitting	Drain SPACE 3,5"

FEATURES

Deep bowls	This bowls reach an important depth, over 20 cm, thanks to the advanced production technology, that can be offer great capiciency and practicity in all the washing operations.
Diamond-shape bottom	The draining of water is an important feature in a sink, and it's always taken good care of in Foster products. In the bent-welded sinks, which would have a flat bottom, the proper draining is guaranteed by the elegant beveling, which helps the water flow.
High thickness	1mm thick steel. A significant thickness, which guarantees the maximum sturdiness and durability.
Perimetral overflow	The overflow is always a security on the Foster sinks that prevents the overflow of water in case of oversights. The perimeter drain solution improves aesthetics thanks to its square and essential shape.
Small radius	Bowls with squared shapes with a modern design and an increased capacity, for a minimal aesthetics connected with an extreme practicity.

TECHNICAL DATA

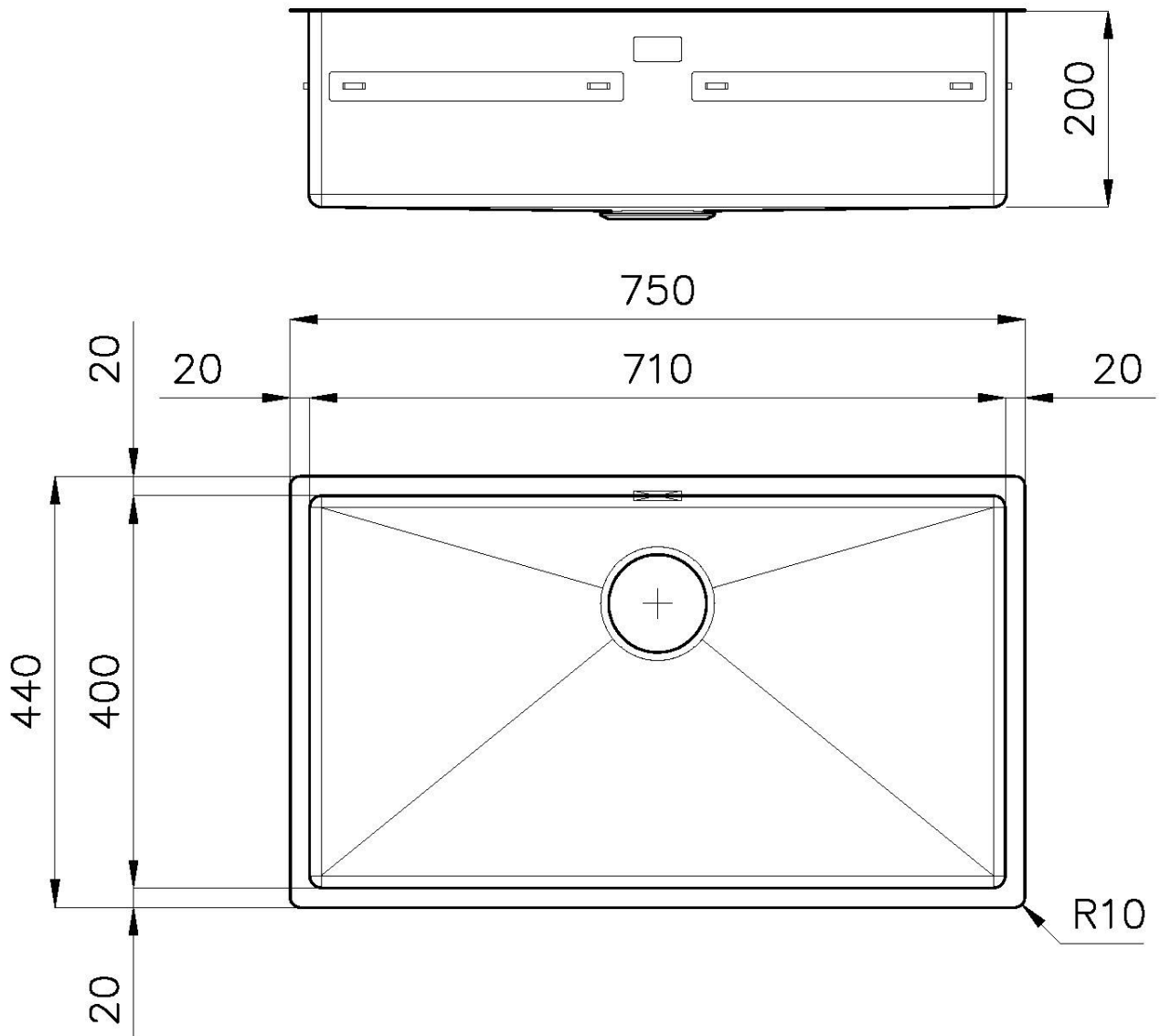

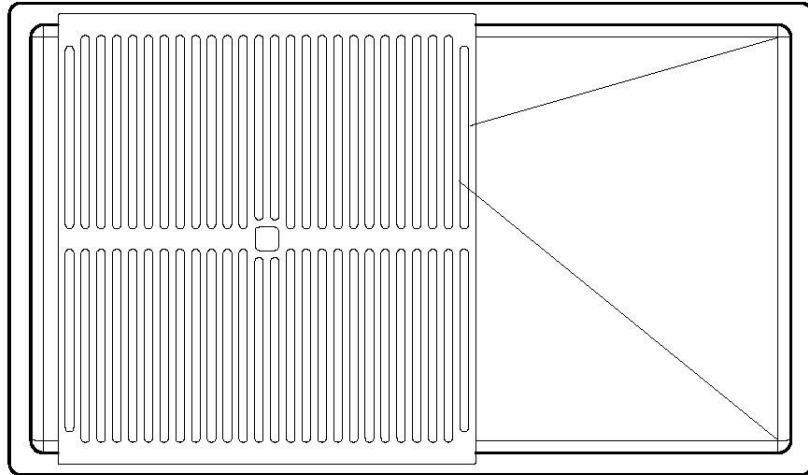

8100 617
POSIZIONATA A FILO VASCA / EDGE POSITIONING



8100 617
POSIZIONATA SUL FONDO / BOTTOM POSITIONING

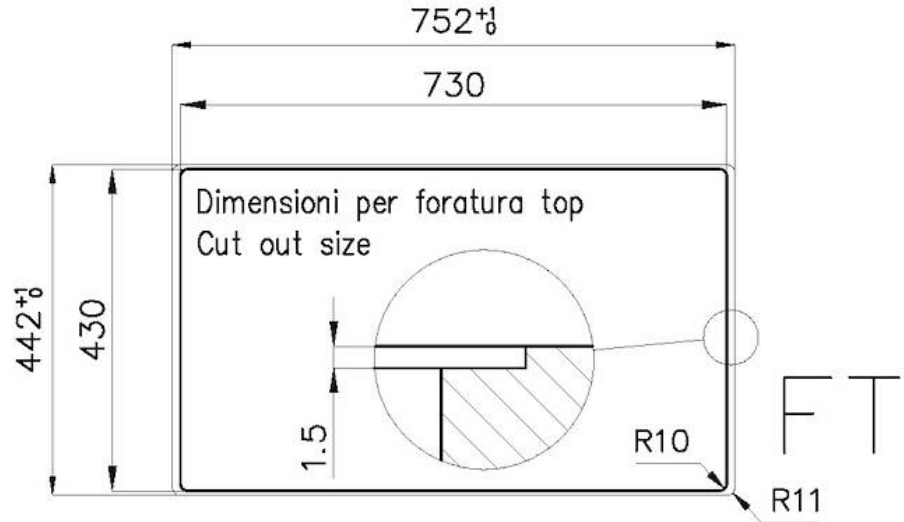

intaglio per il troppo-pieno
solo con top > 30 mm
recess for housing the over-flow
only for top > 30 mm



GALLERY

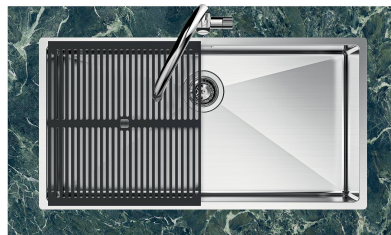

EQUIPMENT



Black grid
8100 617

OPTIONAL ACCESSORIES



Glass chopping board
8631 300



Graters kit with ring-holder and food collection tray

8159 101

* only in combination with the accessory
8644 101



HDPE Chopping board
8657 001



HPDE Twin chopping board
8644 101



Iroko-wood sliding chopping board with stainless steel colander

8644 044



Stainless steel perforated tray

8151 000

* only in combination with the accessory
8644 101



**Stainless steel perforated tray PVD
Copper**

8151 008

* only in combination with the accessory
8644 101



**Stainless steel perforated tray PVD
Gold**

8151 009

* only in combination with the accessory
8644 101



**Stainless steel perforated tray PVD
Gun Metal**

8151 006

* only in combination with the accessory
8644 101



Stainless steel plate rack

8100 303

* only in combination with the accessory
8644 101

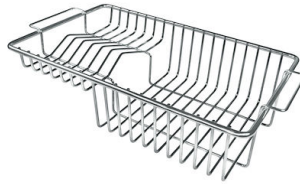

Stainless steel plate rack

8100 201



White bowl

8153 100

RECOMMENDED PAIRINGS



Cooker hob KE

7602 032

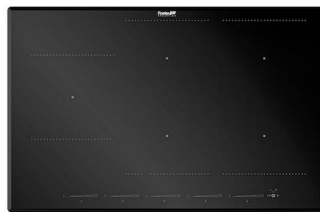

Cooker hob KE Induction

7386 646



Mixer Tap Omega Plus

8497 020

OPTIONAL AUTOMATIC WASTE FITTINGS



Automatic waste fitting - PM
8407 113



Space automatic waste fitting - PA
8407 108



Space automatic waste fitting - PE
8407 109



**Space Light automatic waste fitting
- PL**
8407 117



**Space Push automatic waste fitting
- PP**
8407 116